

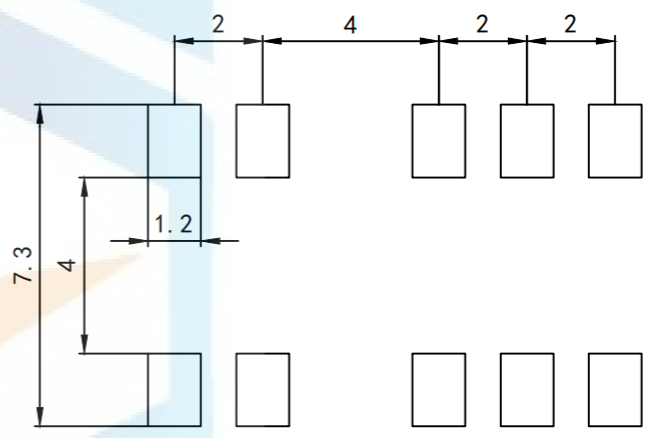

RoHS2.0  
Compliant

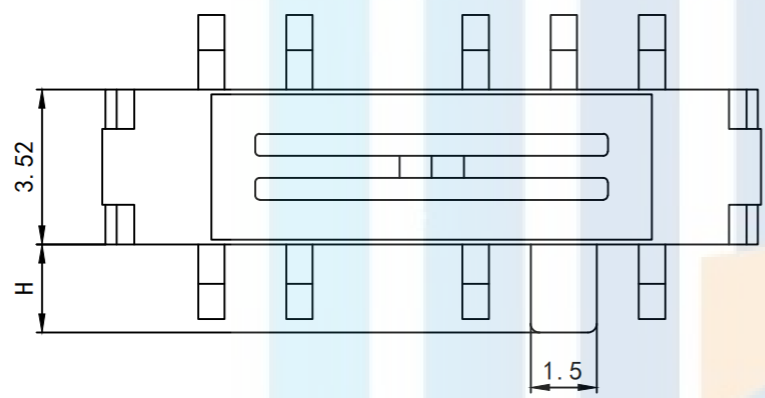
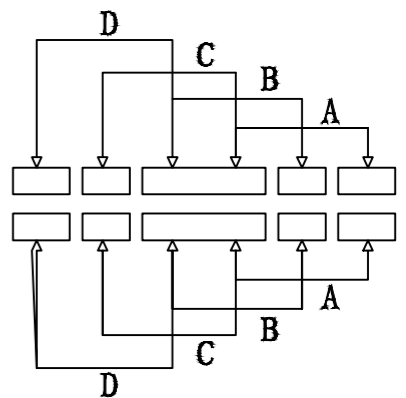
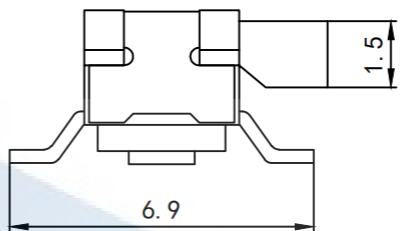
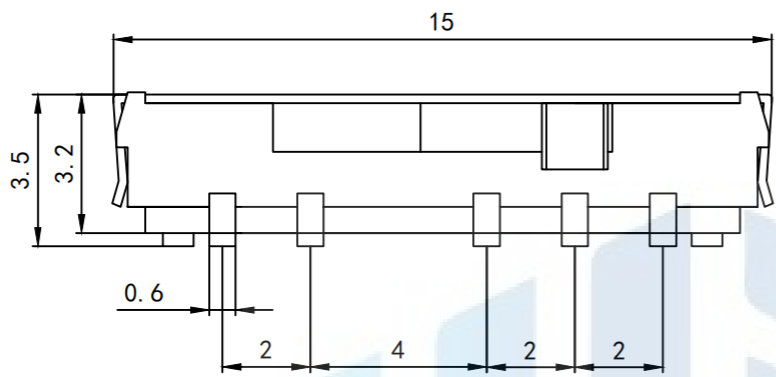
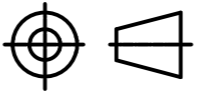

Technical requirements:  
 Rated electrical load: DC12V 0.1A  
 Insulation Resistance:  $\geq 100M\Omega$   
 Compressive Strength: AC250V (50Hz) 1min  
 Ambient Temperature:  $-25^{\circ}C \sim +70^{\circ}C$   
 Relative humidity: ( $40^{\circ}C$ )  $\leq 95\%$   
 Contact Resistance:  $\leq 50M\Omega$   
 Actuation:  $200gf \pm 30gf$   
 Temperature Resistance:  $250^{\circ}$   
 Life span: 10000 times

<b>TOLERANCE</b> X. XXX $\pm 0.05$ X. XX $\pm 0.15$ X. X $\pm 0.20$ X. $\pm 0.30$ ANGLE $\pm 5.0^{\circ}$		<b>东莞市恒祺电子科技有限公司</b> Dongguan Hengqi Electronic Technology Co., Ltd	
		<a href="https://www.hq-dz.com">https://www.hq-dz.com</a> phone: 15812872448	
<b>PROTECTON</b> 	<b>DRAWN:</b>	<b>DATE:</b> 18-10-08	<b>UNIT:</b> mm
	<b>CHECKED:</b>	<b>DATE:</b> 18-10-08	<b>SCALE:</b> FULL
	<b>APPROVED:</b>	<b>DATE:</b> 18-10-08	<b>SIZE:</b> A4
<b>TITLE:</b> 迷你拨动开关		<b>PART NO:</b> MSK-24D20T	
		<b>DRAWING NO:</b> 15*3.5*3.5*H	