

RoHS2.0  
Compliant

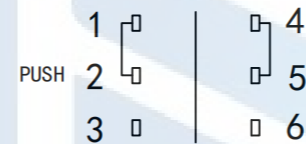

CIRCUIT DIAGRAM

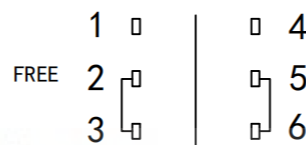
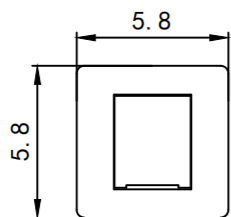
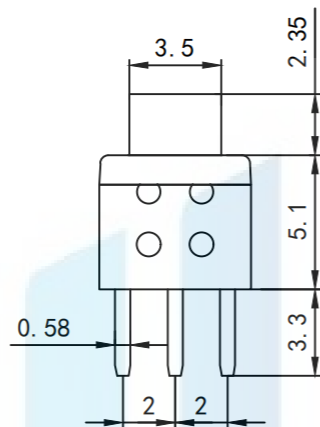
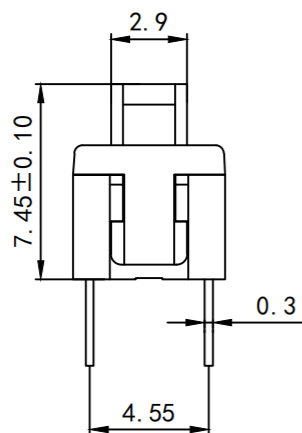
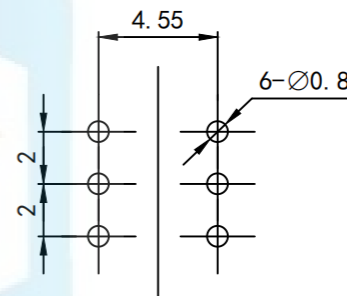
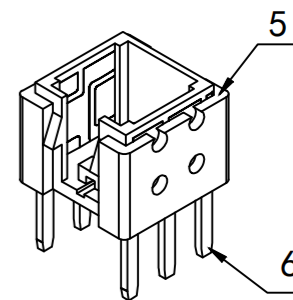
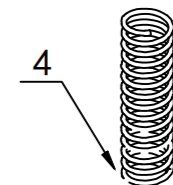
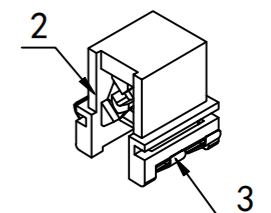
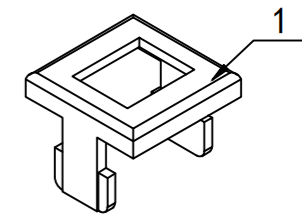
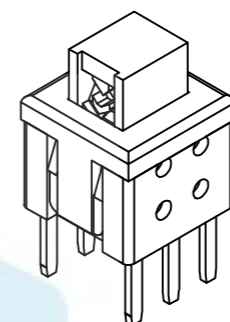
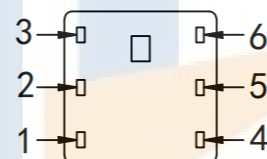

SPECIFICATION:

1. Rated voltage :DC 50V 0.3A
2. Contact resistance :30MΩ MAX less than 30Mω
3. Insulation resistance :100MΩ MIN 100 megohm or more
4. Compressive strength :AC500V (50/60Hz) 1 minute sensitivity current is 0.5mA
5. Operating temperature: -16°C±60°C
6. Mechanical life: 10,000 cycles

TOLERANCE

X. XXX	±0.05
X. XX	±0.15
X. X	±0.20
X.	±0.30
ANGLE	±5.0°

PROTECTON

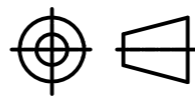

东莞市恒祺电子科技有限公司  
Dongguan Hengqi Electronic Technology Co., Ltd

<https://www.hq-dz.com> phone:15812872448

TITLE:  
按键开关  
自(无)锁 普通款

PART NO:5.8\*5.8双排平头6脚

DRAWING NO:5.8\*5.8\*7.45

DRAWN:  
CHECKED:  
APPROVED:

DATE: 18-10-08  
DATE: 18-10-08  
DATE: 18-10-08

UNIT: mm  
SCALE: FULL  
SIZE: A4