

RoHS2.0
Compliant

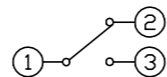

电路原理图

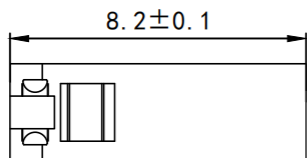
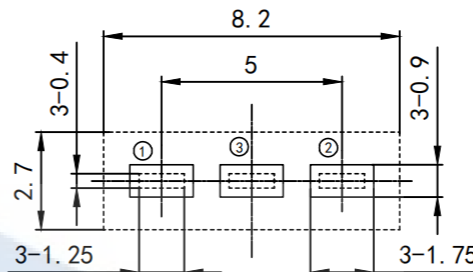

PCB图

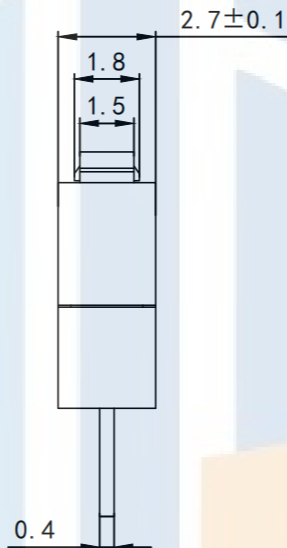
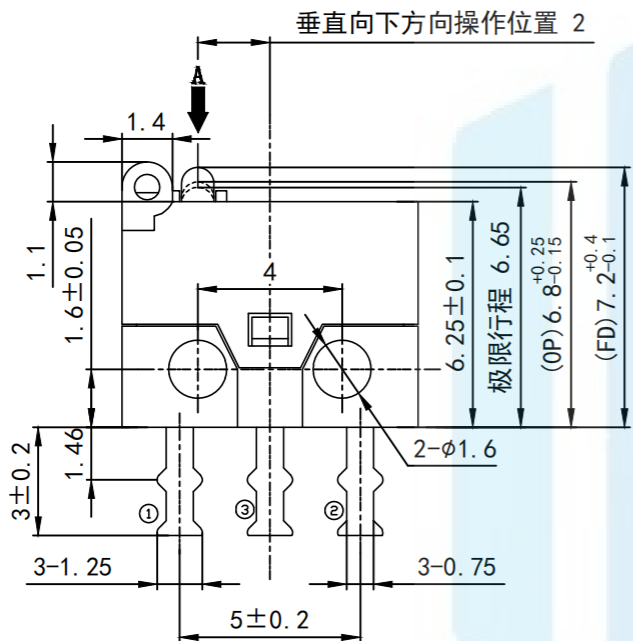
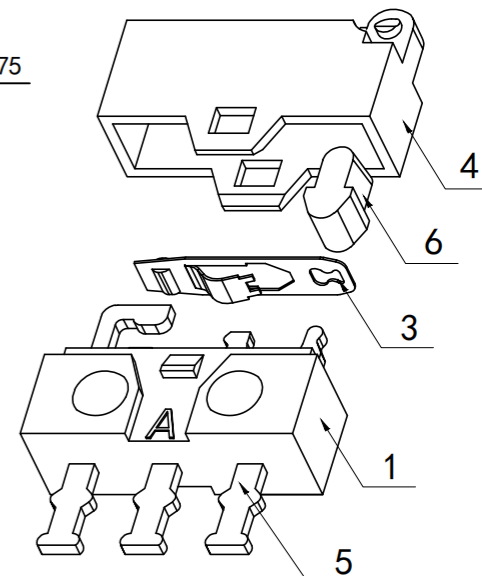

Technical requirements

- Rated voltage: 16V (DC)
Rated current: 0.5A
- Switching insulation resistance: $\geq 50M\Omega$
- Switch contact resistance: $\leq 200m\Omega$
- Driving force: $80g \pm 20g$
- The life of the switch requires ≥ 20000 cycles.
- The unmarked dimensional tolerance is required according to GB/T1804-m level accuracy

TOLERANCE

X. XXX	± 0.05
X. XX	± 0.15
X. X	± 0.20
X.	± 0.30
ANGLE	$\pm 5.0^\circ$

PROTECTON

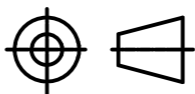

东莞市恒祺电子科技有限公司
Dongguan Hengqi Electronic Technology Co., Ltd

<https://www.hq-dz.com>

phone: 15812872448

TITLE:
限位开关

PART NO: HQ-KFC-V-307无柄

DRAWING NO: 8.2*2.7*6.25

DRAWN:

DATE: 18-10-08

UNIT:
mm

CHECKED:

DATE: 18-10-08

SCALE:
FULL

APPROVED:

DATE: 18-10-08

SIZE:
A4