

RoHS2.0
Compliant

负极面涂蓝色

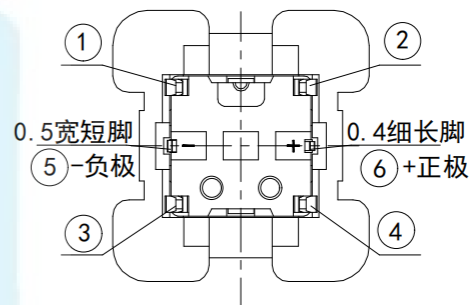
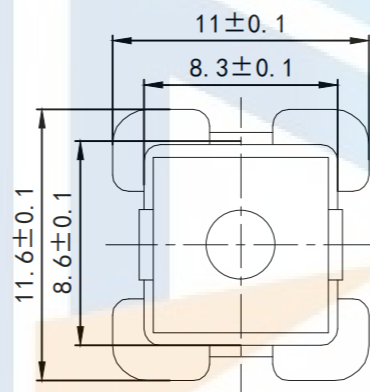
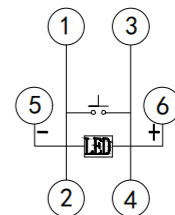
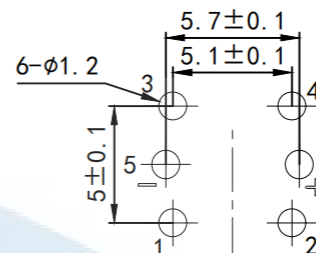
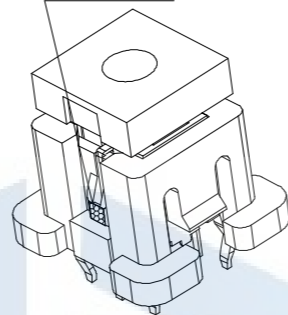
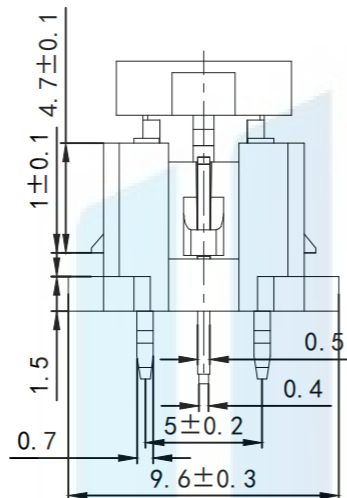
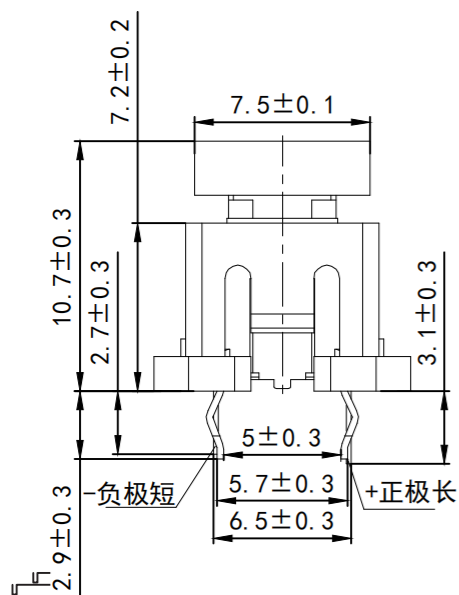

Main Specifications:

1. climate Grade: 25°C or +75°C
2. Rated Values: 30V DC, 30mA
3. Contact Resistance: < 0.05 Ω
4. Dielectric Strength: 250V AC
5. Insulation Resistance: > 100M Ω
6. Operating Force: 260gf + 50gf
7. Life: 10W times
8. Salt mist Test: 12+1 hours.

TOLERANCE

X. XXX	±0.05
X. XX	±0.15
X. X	±0.20
X.	±0.30
ANGLE	±5.0°

PROTECTON

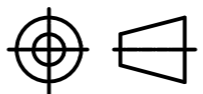

东莞市恒祺电子科技有限公司

Dongguan Hengqi Electronic Technology Co., Ltd

<https://www.hq-dz.com>

phone: 15812872448

TITLE:

带灯轻触开关

PART NO: HQ-TS-H009

DRAWING NO: 10.7*9.6*11.6

DRAWN:

CHECKED:

APPROVED:

DATE:

DATE:

DATE:

18-10-08

18-10-08

18-10-08

UNIT:
mm

SCALE:
FULL

SIZE:
A4