

RoHS2.0  
Compliant

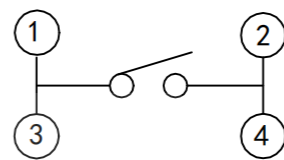

CIRCUIT

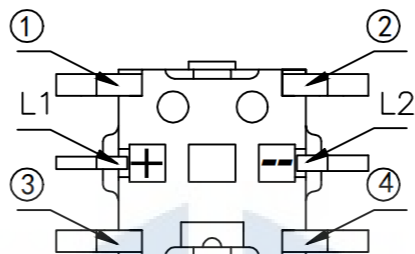
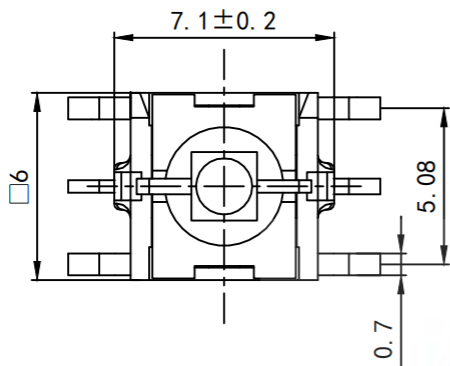
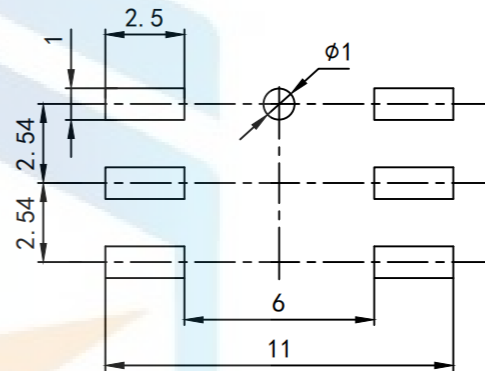
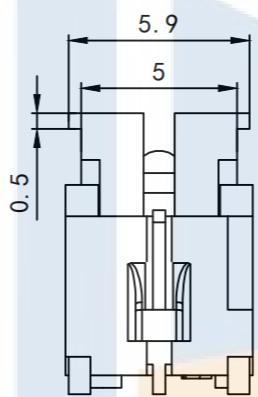
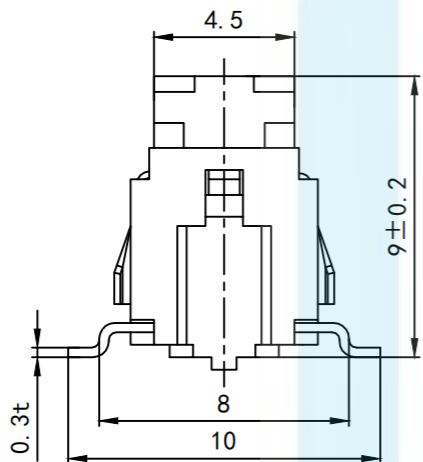
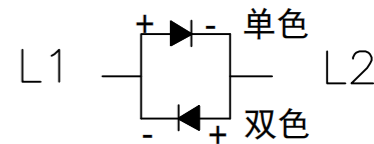

P. C. B LAYOUT

NOTES:

1. RATING: 12VDC50Ma
2. CONTACT RESISTANCE: 100m<sup>2</sup> Max
3. INSULATION RESISTANCE: 100M 250DCFOR1MIN
4. DIELECTRIC STRENGTH: 250VAC (50/60Hz) FOR 1MIN
5. LIFE TEST: 100,000 CYCLES
6. OPERATION FORCE&TRAVEL: SEE SPECIFICATION

TOLERANCE			东莞市恒祺电子科技有限公司		
X. XXX	±0.05		Dongguan Hengqi Electronic Technology Co., Ltd		
X. XX	±0.15	https://www.hq-dz.com		phone: 15812872448	
X. X	±0.20	TITLE: 带灯轻触开关		PART NO: HQ-TS-H005	
X.	±0.30	DRAWING NO: 6*6*9			
ANGLE	±5.0°	DRAWN:		DATE: 18-10-08	
PROTECTON		CHECKED:		DATE: 18-10-08	
		APPROVED:		DATE: 18-10-08	
				UNIT: mm	
				SCALE: FULL	
				SIZE: A4	