

RoHS2.0
Compliant

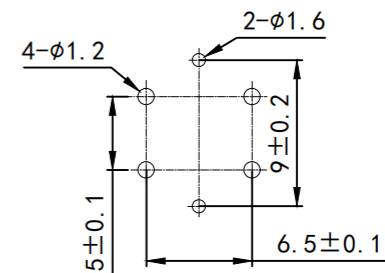
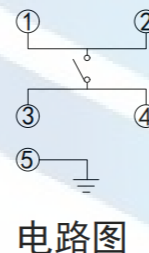
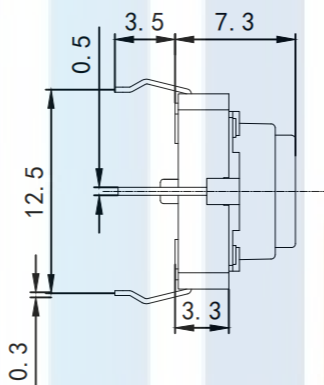
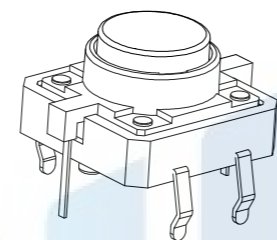
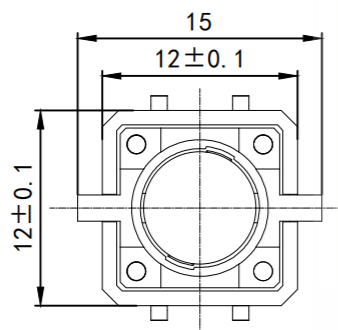
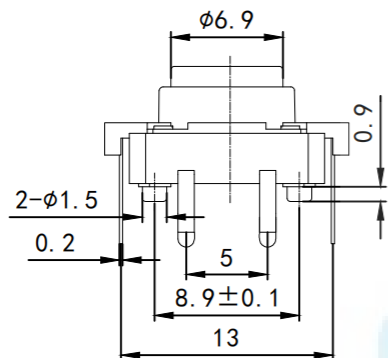

线路板安装孔尺寸

Technical requirement

1. Rated voltage and current :DC 12V 50mA;
2. Travel :0.35mm
3. Action force :70~100gf
4. Life :100000 times
5. Unmarked tolerance of linear dimension is 0.2mm

TOLERANCE

X. XXX	±0.05
X. XX	±0.15
X. X	±0.20
X.	±0.30
ANGLE	±5.0°

PROTECTON

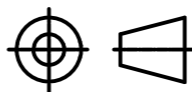

东莞市恒祺电子科技有限公司

Dongguan Hengqi Electronic Technology Co., Ltd

<https://www.hq-dz.com>

phone:15812872448

TITLE:
带灯轻触开关

PART NO:HQ-TS-G010

DRAWING NO:12*12*7.3

DRAWN:

DATE: 18-10-08

UNIT:
mm

CHECKED:

DATE: 18-10-08

SCALE:
FULL

APPROVED:

DATE: 18-10-08

SIZE:
A4