

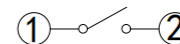

RoHS2.0
Compliant

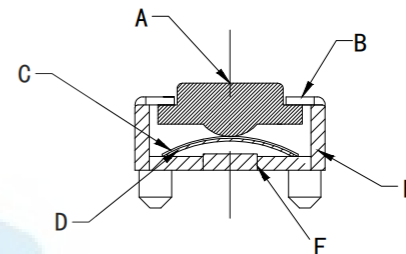
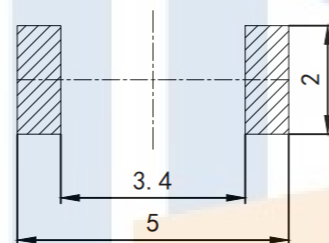
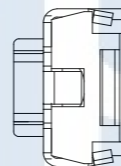
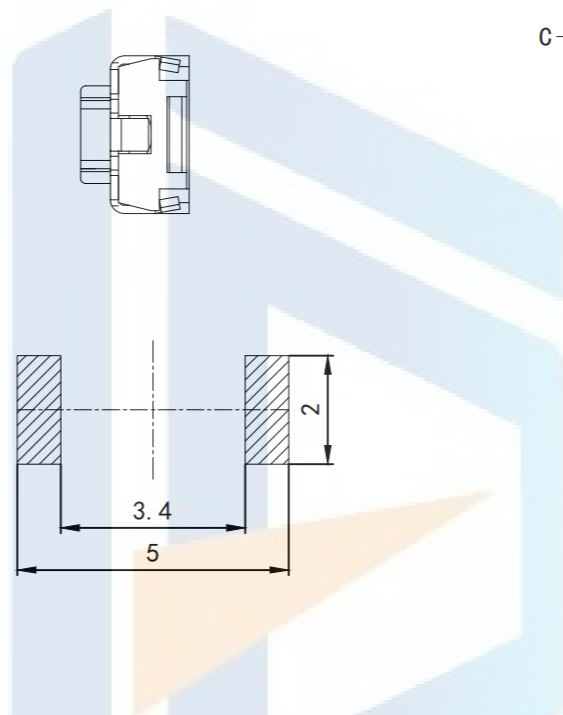
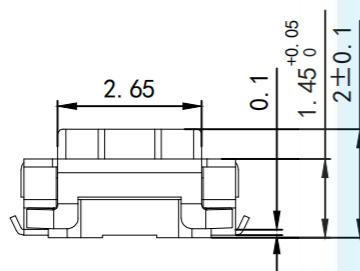
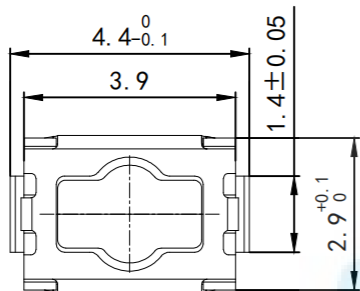

SPECIFICATION

1. Rated Current:50mA
2. Rated voltage:DC12V
3. Contact resistance: $\geq 50m\Omega$
4. Insulation Resistance: $\geq 100M\Omega$
5. Compressive strength:AC250V 50Hz/1min
6. Operating force:200+50gf
7. Mechanical life;50,000 cycles Min
8. Operation Stroke:0.15+0.05mm
9. emperature Range:-25° C TO +70° 0

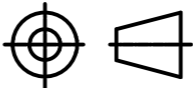
TOLERANCE X. XXX ±0.05 X. XX ±0.15 X. X ±0.20 X. ±0.30 ANGLE ±5.0°		东莞市恒祺电子科技有限公司 Dongguan Hengqi Electronic Technology Co., Ltd	
		https://www.hq-dz.com phone:15812872448	
PROTECTON 	TITLE: 轻触开关	PART NO: HQ-TS-A014-1	
	DRAWN:	DRAWING NO: 3*4*2U脚	
	CHECKED:	DATE: 18-10-08	UNIT: mm
APPROVED:	DATE: 18-10-08	SCALE: FULL	
	DATE: 18-10-08	SIZE: A4	