

RoHS2.0
Compliant ✓

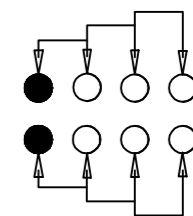

SCHMATIC

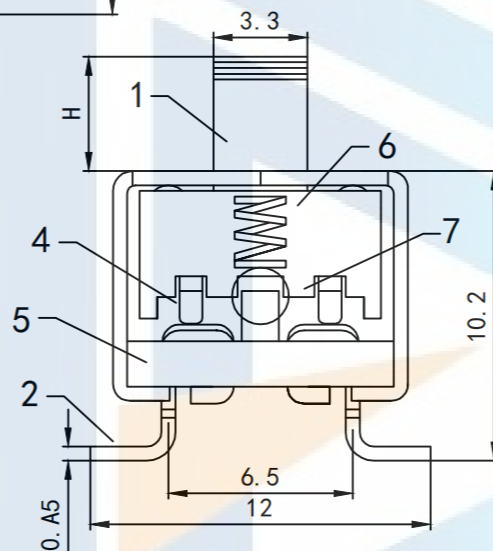
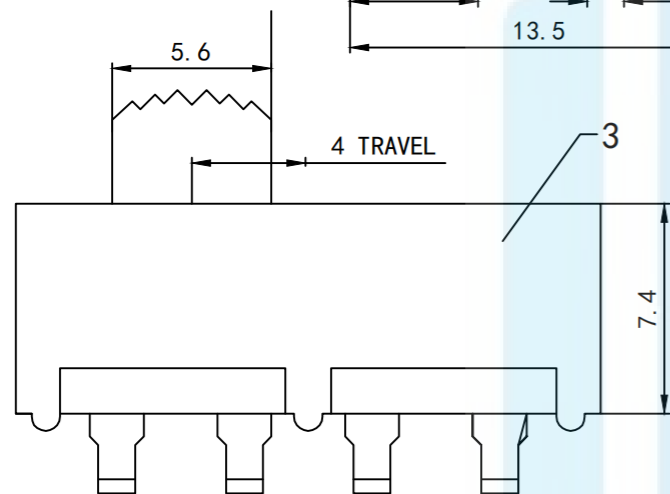
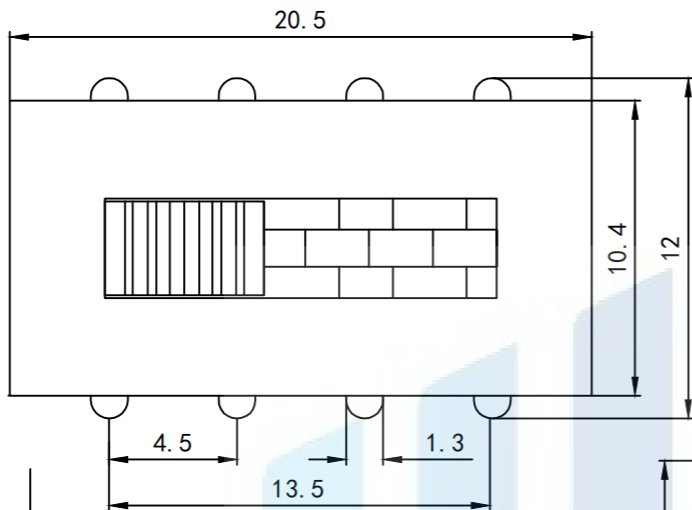
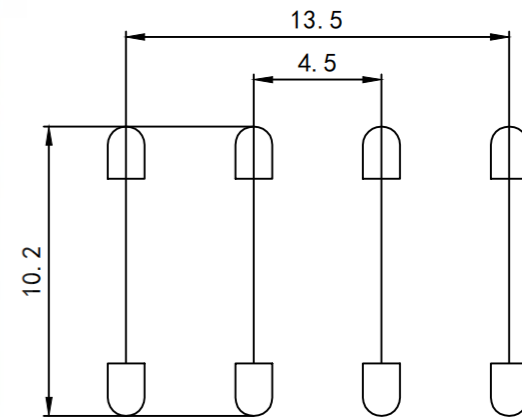

P. C. B LAYOUT
BOTTOM VIEW

Electrical performance parameters:

1. Rated load :AC125V 3A
2. Contact resistance: less than 100 milliohm
3. Insulation resistance :100 megohm to _
- 4 Endurance life pressure :AC 500V
- 5 degrees :350 ° 100gf
6. Life :5000 times
7. Wave peak welding :255 degrees 5

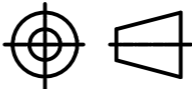
TOLERANCE X. XXX ±0.05 X. XX ±0.15 X. X ±0.20 X. ±0.30 ANGLE ±5.0°		东莞市恒祺电子科技有限公司 Dongguan Hengqi Electronic Technology Co., Ltd	
		https://www.hq-dz.com phone:15812872448	
PROTECTON 	TITLE: 拨动开关		PART NO: SS-23H20贴片
	DRAWN:		DRAWING NO: 20.5*10.4*H
	CHECKED:	DATE: 18-10-08	UNIT: mm
APPROVED:	DATE: 18-10-08	SCALE: FULL	
	DATE: 18-10-08	SIZE: A4	