

RoHS2.0
Compliant ✓

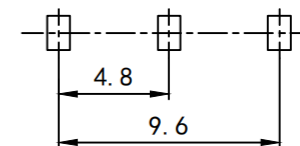

P. C. B LAYOUT
BOTTOM VIEW

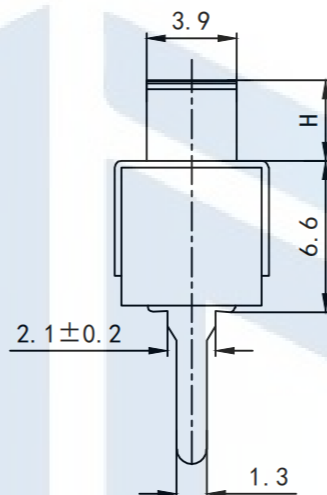
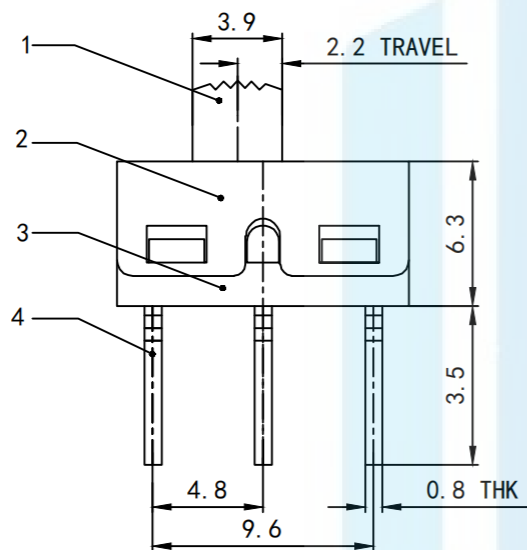
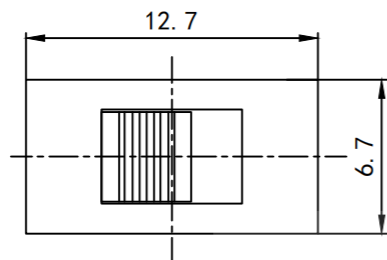
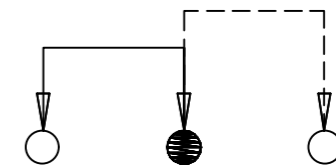

SCHEMATIC (NON-SHORTING)

Electrical performance parameters:

1. Rated load :AC125V 3A
2. Contact resistance: less than 100 milliohm
3. Insulation resistance: more than 100 megohm
4. Pressure resistance :AC 500V
5. Strength :350±100gf
6. Life span :5000 times
7. Wave peak welding :255±5 degrees

TOLERANCE

X. XXX	±0.05
X. XX	±0.15
X. X	±0.20
X.	±0.30
ANGLE	±5.0°

PROTECTON



东莞市恒祺电子科技有限公司

Dongguan Hengqi Electronic Technology Co., Ltd

<https://www.hq-dz.com>

phone:15812872448

TITLE:

拨动开关

PART NO:SS-12D10针3.5

DRAWING NO:12.7*6.7*H

DRAWN:

DATE:

18-10-08

UNIT:
mm

CHECKED:

DATE:

18-10-08

SCALE:
FULL

APPROVED:

DATE:

18-10-08

SIZE:
A4