

RoHS2.0
Compliant

口部及6个弹片两侧倒C脚

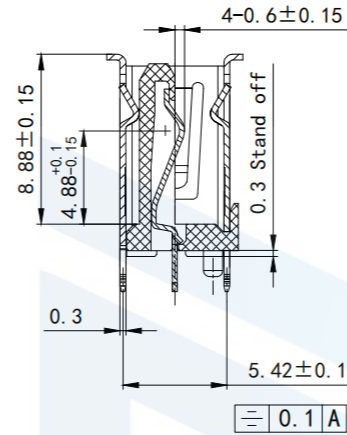

SECTION A-A
SCALE 1:1

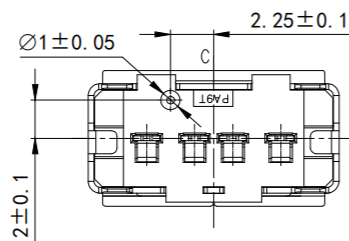
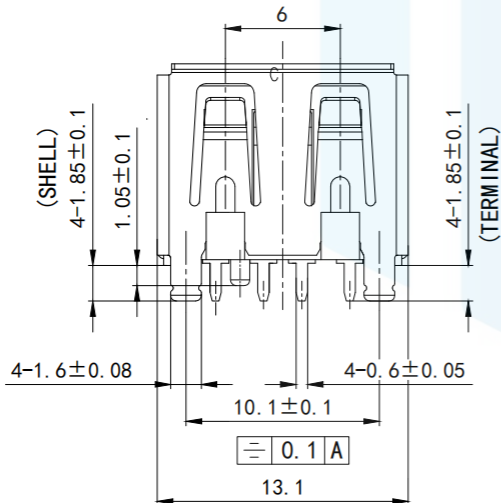
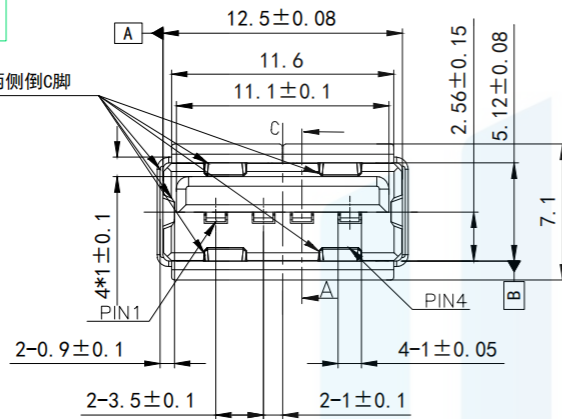
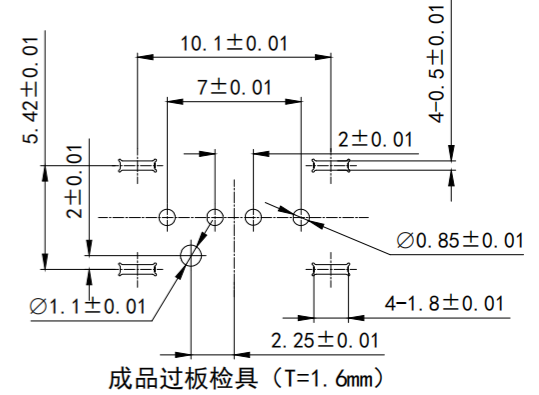
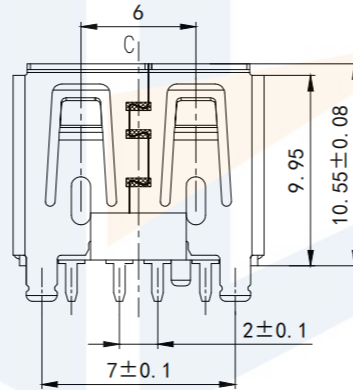

成品过板检具 (T=1.6mm)

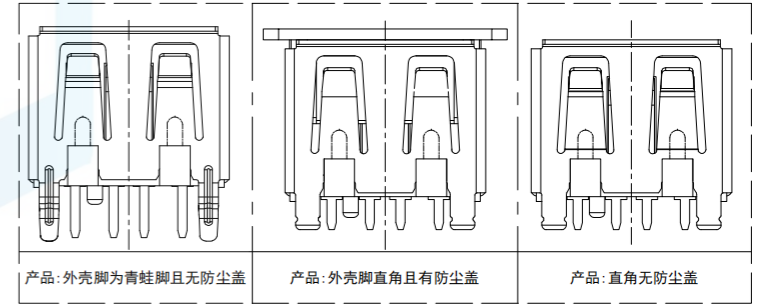

TOLERANCE

X. XXX	±0.05
X. XX	±0.15
X. X	±0.20
X.	±0.30
ANGLE	±5.0°

PROTECTON

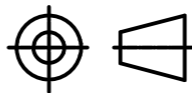

东莞市恒祺电子科技有限公司

Dongguan Hengqi Electronic Technology Co., Ltd

<https://www.hq-dz.com>

phone: 15812872448

TITLE:

USB2.0 A/F立式插板
5定位脚插板

PART NO: USB2.0-A522

DRAWING NO: 10.55*13.1*7.1

DRAWN:

DATE:

18-10-08

UNIT:
mm

CHECKED:

DATE:

18-10-08

SCALE:
FULL

APPROVED:

DATE:

18-10-08

SIZE:
A4