

RoHS2.0
Compliant

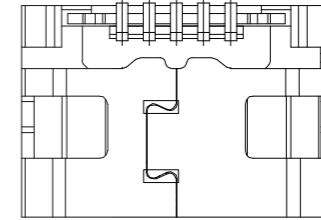
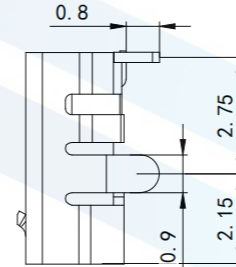
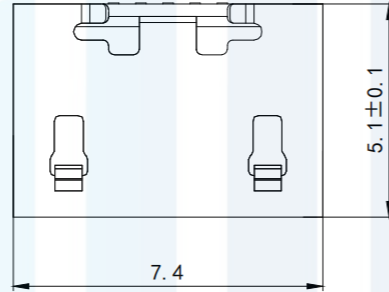
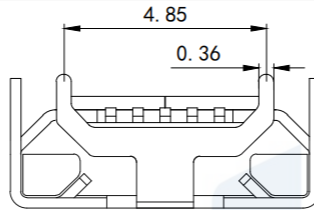
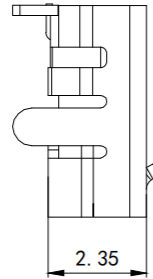

Specifications:
Electrical.

1. Current Rating: 1.5A/contact terminal Pin1
2. Voltage Rating: 30VDC
3. Contact Resistance: 30 milliohms MAX
4. Dielectric Withstanding Voltage: 100V AC AT Sea Level
5. Insulation Resistance: 1000MEGA ohms MIN

1. Connector Mate and Unmate Force: 3.57kaf (MAX)

Unmate force: 1.02kgf (MIN)

2. Frequency: 3000次: 3000Cycles

Material:

1. Housing: High Temperature Thermoplastics U1 94V-0 LCP White/Black
2. Contact: Copper Alloy C5191
3. Shell: Copper Alloy C2680

Finish:

1. Contact: Plated Gold in Mating Area; 半金锡1U
2. Shell: Nickel Plating

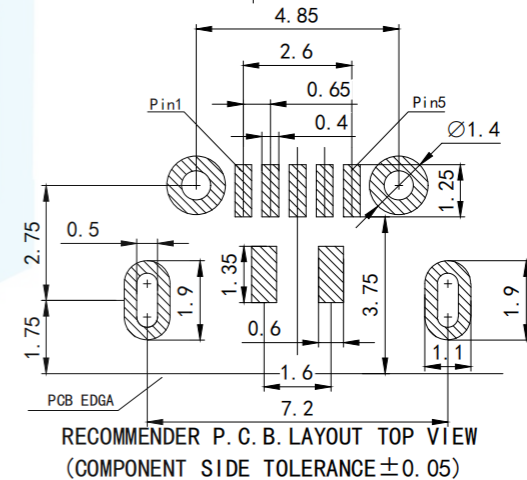
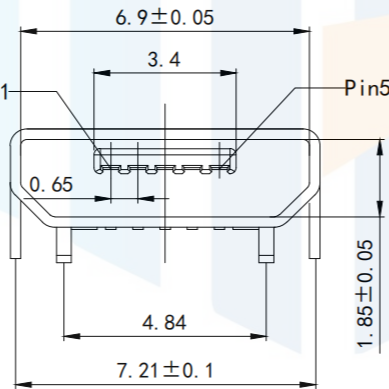

TOLERANCE

X. XXX	±0.05
X. XX	±0.15
X. X	±0.20
X.	±0.30
ANGLE	±5.0°

PROTECTON

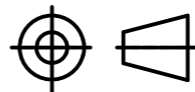

东莞市恒祺电子科技有限公司

Dongguan Hengqi Electronic Technology Co., Ltd

<https://www.hq-dz.com>

phone: 15812872448

TITLE:

Micro usb 5P小牛角无卷边

PART NO: MICRO5P-PS51NJ

DRAWING NO: 7.4*5.1*2.35

DRAWN:

DATE:

18-10-08

UNIT:
mm

CHECKED:

DATE:

18-10-08

SCALE:
FULL

APPROVED:

DATE:

18-10-08

SIZE:
A4