

RoHS2.0  
Compliant

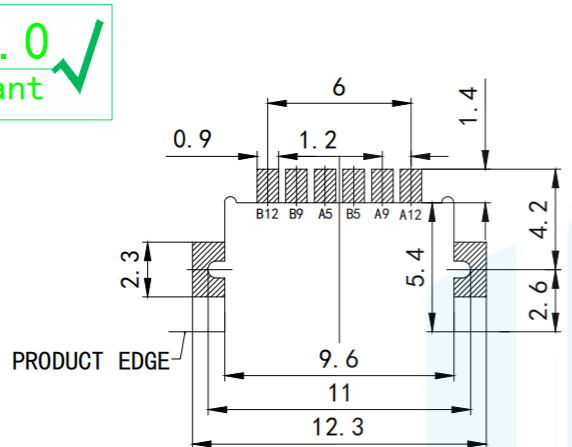

RECOMMEND P.C.B LAYOUT (COMPONENT SIDE)  
TOLERANCE FOR PCB LAYOUT IS  $\pm 0.05$

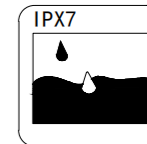
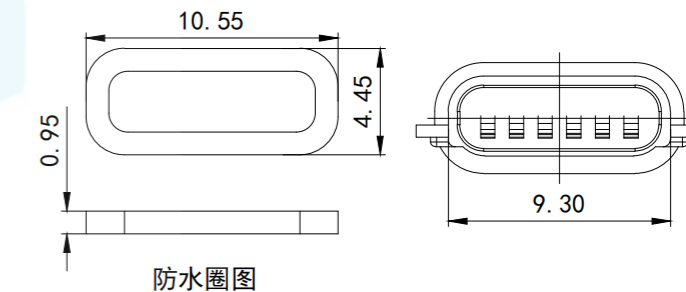
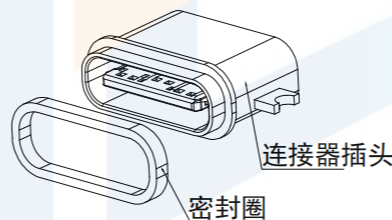
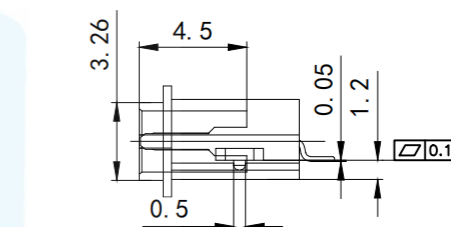
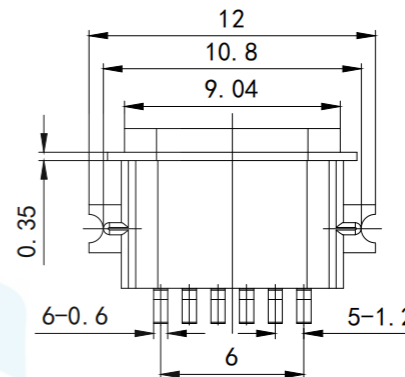
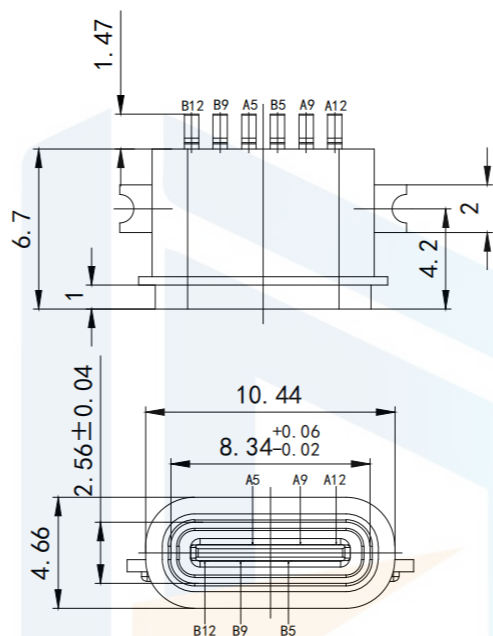

NOTE:

1. Electrical characteristics:
  - 1.1. Contact area: contact resistance 40mΩ Max, allowing 10mΩ variation  
Test conditions :20mv, 100mA measurement.
  - 1.2. Contact current: 3A VBUS pin; 1.25A for GND Pin; The other pins are 0.25A.
  - 1.3. Rated voltage: 5V.
  - 1.4. Withstand voltage: 100VAC.
  - 1.5. Insulation resistance: at least 100 megohm.
2. Mechanical properties:
  - 3.1. Insertion force: 0.5-2.0Kg
  - 3.2. Pullout force: 0.6-2.04Kg
  - 3.3. Insertion and removal times: 10000 times.
  4. Weldability: temperature 210-230°C, time 10 seconds
  5. Working environment: -20°C to +85°C.

TOLERANCE			东莞市恒祺电子科技有限公司 Dongguan Hengqi Electronic Technology Co., Ltd		
X. XXX	±0.05		https://www.hq-dz.com		phone:15812872448
X. XX	±0.15	TITLE: TYPE C 6P 沉板1.2防水母座L=6.7mm 外壳粉末冶金		PART NO:TYPE-C6P-CB1127FS	
X. X	±0.20			DRAWING NO:12*4.66*6.7	
X.	±0.30				
ANGLE	±5.0°				
PROTECTON		DRAWN:		DATE: 18-10-08	UNIT: mm
		CHECKED:		DATE: 18-10-08	SCALE: FULL
		APPROVED:		DATE: 18-10-08	SIZE: A4