

RoHS2.0
Compliant

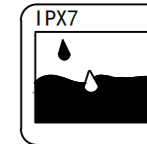
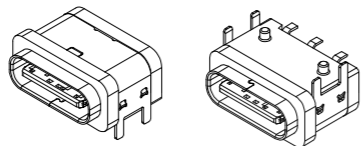

NOTES:

SPECIFICATION:

1. CURRENT RATING: 3.0 A
2. VOLTAGE RATING: 3.0 V
3. VBUS & GND PINS AND OTHER PINS:
40mΩ/PIN MAX
- SHIELD: 50mΩ/MAX
- LLCR MAX. CHANGE OF ALL PINS: 10Ωm
4. INSULATION RESISTANCE: 100MΩ MIN
5. DIELECTRIC WITHSTAND VOLTAGE, AC 100V
FOR 1MINUTE
6. INSERTION FORCE: 0.5~2.0kgf
7. UNMATING FORCE: 0.8~2.0kgf
8. DURABILITY: 10000 CYCLES
9. OPERATING TEMPERATURE: -35° C~+85° C
10. THE PEAK TEMPERATURE ON THE BOARD
SHALL BE MAINTAINED FOR 10 SECONDS AT
210-230° C
11. WATERPROOF: IP-X7.

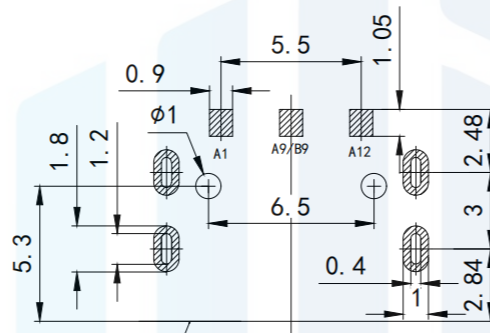
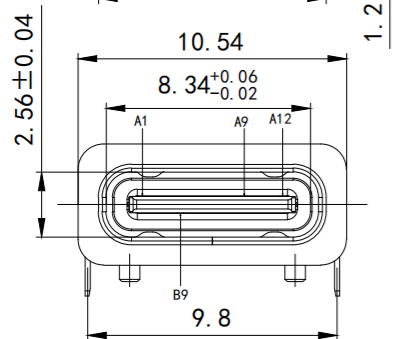
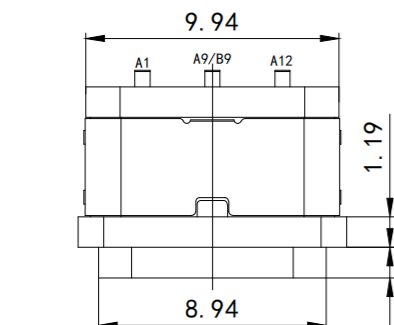

PRODUCT EDGE
RECOMMEND P.C.B LAYOUT (COMPONENT SIDE)
TOLERANCE FOR PCB LAYOUT IS ±0.05

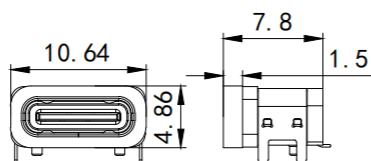
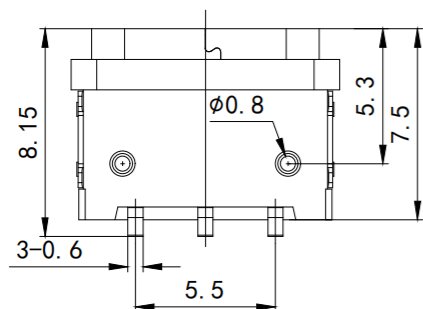
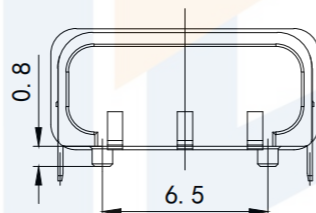
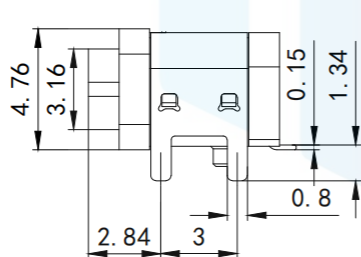

加防水圈示意图

TOLERANCE			东莞市恒祺电子科技有限公司 Dongguan Hengqi Electronic Technology Co., Ltd		
X. XXX	±0.05		https://www.hq-dz.com phone:15812872448		
X. XX	±0.15	TITLE: TYPE C 3P 板上防水母座L=7.5mm 外壳4脚插板		PART NO:TYPE-C3P-BS1075FS	
X. X	±0.20			DRAWING NO:10.54*4.76*7.5	
X.	±0.30				
ANGLE	±5.0°				
PROTECTON		DRAWN:		DATE:	18-10-08
		CHECKED:		DATE:	18-10-08
		APPROVED:		DATE:	18-10-08
				UNIT:	mm
				SCALE:	FULL
				SIZE:	A4