

RoHS2.0
Compliant

NOTE:

1. MATERIAL SPECIFICATION:
 1. HOUSING: HIGH TEMPERATURE RESISTANT PLASTIC, UL94 V-0.
 2. CONTACTS: COPPER ALLOY
 3. MID PLATE: STAINLESS STEEL
2. PLATING SPECIFICATION:
 - 2-1. CONTACTS:
 - Ni 50U" MIN. UNDER PLATED OVER ALL.
 - AU PLATED ON THE FUNCTIONAL AREA OF CONTACT (GOLD PLATING THICKNESS FOLLOW THE P/N)
 - GOLD FLASH PLATING ON SOLDER AREA
 - 2-2. FRONT SHELL:
 - Ni 30U" MIN. UNDER PLATED OVER ALL
3. MECHANICAL PERFORMANCE,
 - 3-1. INSERTION FORCE: 0.5~2.0kgf.
 - 3-2. REMOVAL FORCE: 0.8kgf~2.0kgf.
 - 3-3. DURABILITY: 10000 CYCLES.
4. ELECTRICAL PERFORMANCE,
 - 4-1. CURRENT RATING: 5A
VOLTAGE RATING: 20V
 - 4-2. INSULATION RESISTANCE: 100MΩ MIN
 - 4-3. DIELECTRIC WITHSTAND VOLTAGE, AC 100V FOR 1 MINUTE
 - 4-4. LOW CONTACT RESISTANCE: INITIAL 40M2 AFTER 50M2
5. ENVIRONMENTAL PERFORMANCE: OPERATING TEMPERATURE: -30°C~+80°C
6. IR REFLOW:
 - THE PEAK TEMPERATURE ON THE BOARD SHALL BE MAINTAINED FOR 10 SECONDS AT 260C

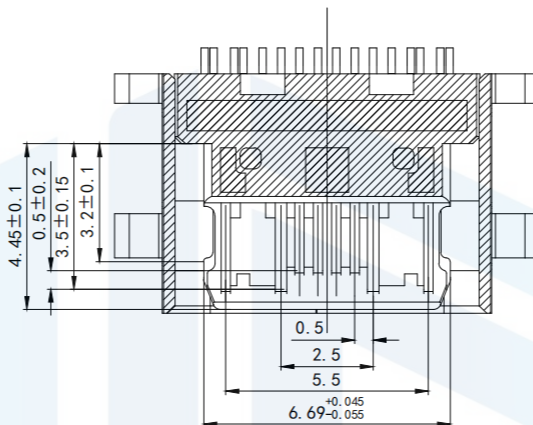
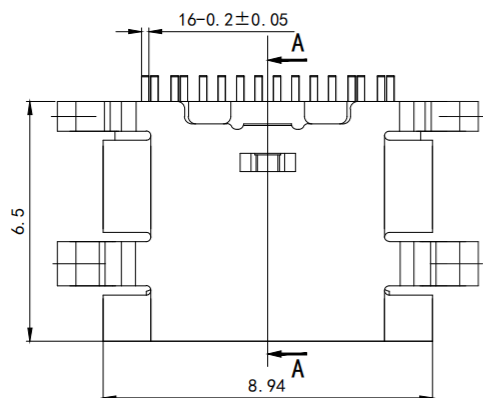

SECTION B-B
SCALE 1:1

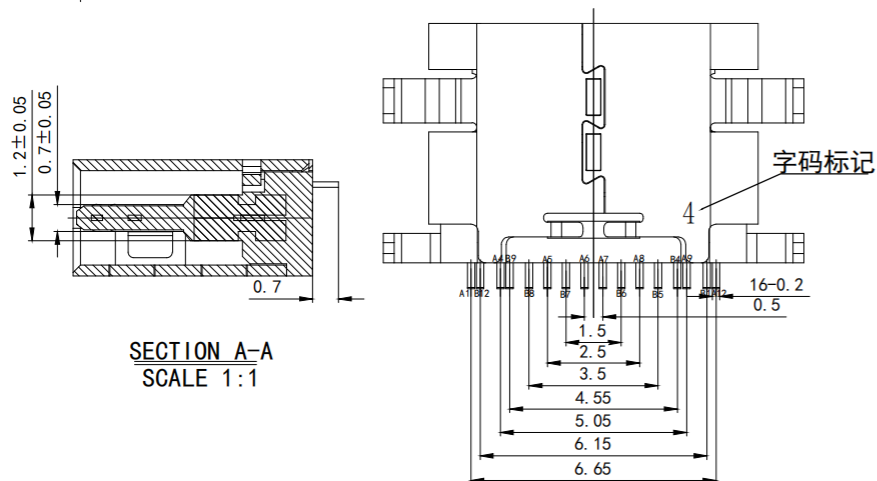
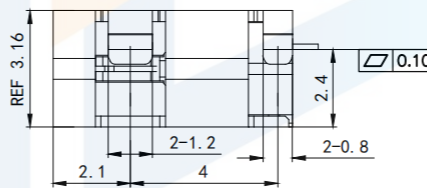
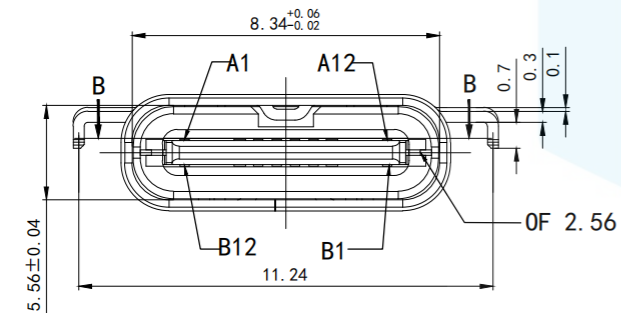

SECTION A-A
SCALE 1:1

TOLERANCE

X. XXX	±0.05
X. XX	±0.15
X. X	±0.20
X.	±0.30
ANGLE	±5.0°

PROTECTON

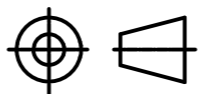

东莞市恒祺电子科技有限公司
Dongguan Hengqi Electronic Technology Co., Ltd

<https://www.hq-dz.com>

phone: 15812872448

TITLE:
TYPE C 16P沉板2.4
4定位脚外移插板

PART NO: TYPE-C16P-CB024

DRAWING NO: 8.94*6.5*3.16

DRAWN:

DATE: 18-10-08

UNIT:
mm

CHECKED:

DATE: 18-10-08

SCALE:
FULL

APPROVED:

DATE: 18-10-08

SIZE:
A4

RoHS2.0
Compliant ✓

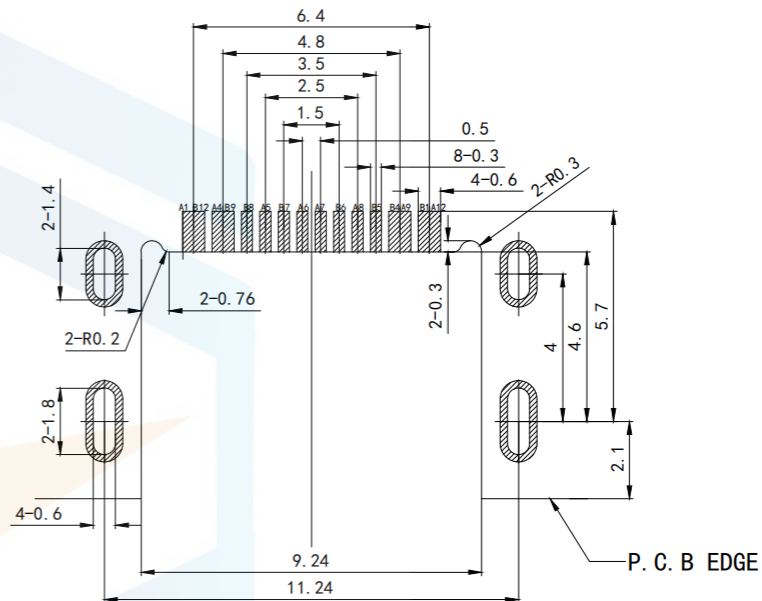
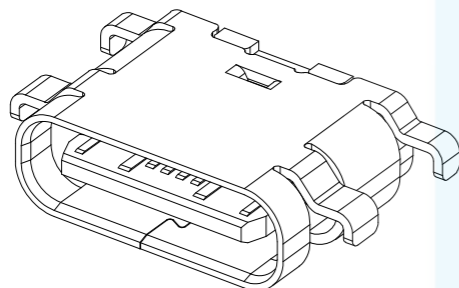

RECOMMENDED PCB LAYOUT (COMPONENT SIDE)
TOLERANCE UNSPECIFIED $\pm 0.05\text{mm}$

USB TYPE-C PIN ASSIGNMENTS

PIN NUMBER	SIGNAL NAME	PIN NUMBER	SIGNAL NAME
A1	GND	B12	GND
A4	VBUS	B9	VBUS
A5	CC1	B8	SBU2
A6	DN1	B7	DN1
A7	DP1	B6	DP1
A8	SBU1	B5	CC2
A9	VBUS	B4	VBUS
A12	GND	B1	GND

TOLERANCE X. XXX ± 0.05 X. XX ± 0.15 X. X ± 0.20 X. ± 0.30 ANGLE $\pm 5.0^\circ$		东莞市恒祺电子科技有限公司 Dongguan Hengqi Electronic Technology Co., Ltd	
		https://www.hq-dz.com phone: 15812872448	
PROTECTON 	TITLE: TYPE C 16P沉板2.4 4定位脚外移插板		PART NO: TYPE-C16P-CB024
	DRAWN:		DRAWING NO: 8.94*6.5*3.16
	CHECKED:	DATE: 18-10-08	UNIT: mm
APPROVED:	DATE: 18-10-08	SCALE: FULL	
	DATE: 18-10-08	SIZE: A4	