

RoHS2.0  
Compliant

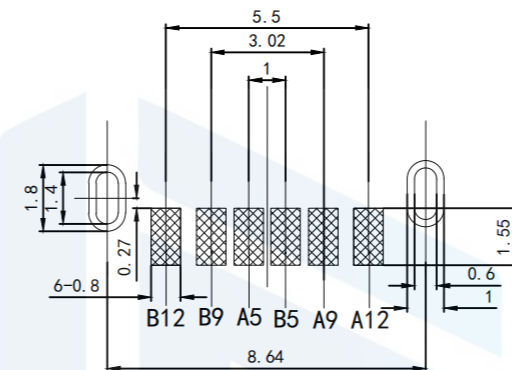

RECOMMENDED PCB LAYOUT  
TOLERANCE UNSPECIFIED ±0.05mm

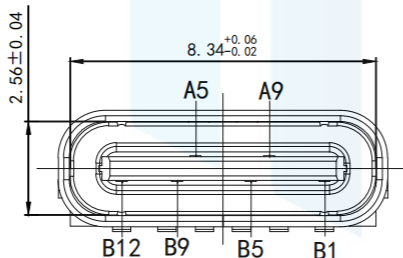
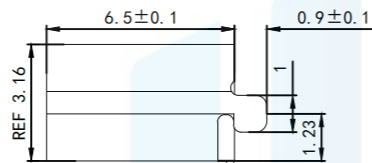
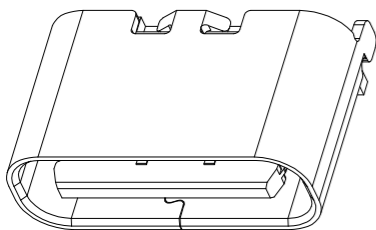
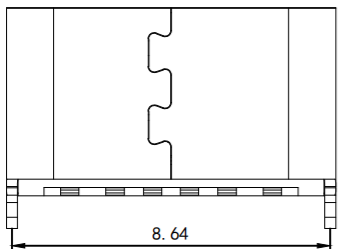
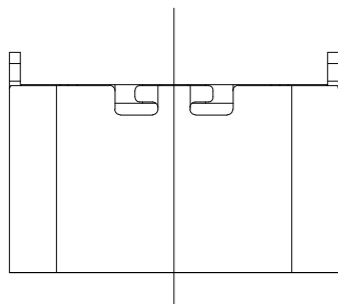
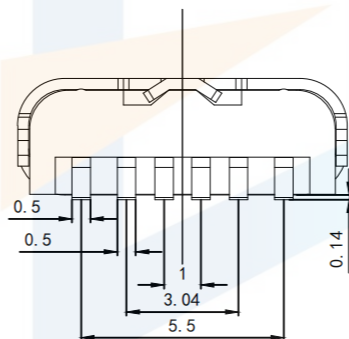

NOTE:

- MATERIAL SPECIFICATION:
  - HOUSING: HIGH TEMPERATURE RESISTANT PLASTIC, UL94 V-0.
  - CONTACTS: COPPER ALLOY
  - MID PLATE: STAINLESS STEEL
- PLATING SPECIFICATION:
  - CONTACTS:
    - Ni 50U" MIN. UNDER PLATED OVER ALL. AU PLATED ON THE FUNCTIONAL AREA OF CONTACT (GOLD PLATING THICKNESS FOLLOW THE P/N) GOLD FLASH PLATING ON SOLDER AREA
    - FRONT SHELL:
      - Ni 30U" MIN. UNDER PLATED OVER ALL
- MECHANICAL PERFORMANCE,
  - INSERTION FORCE: 0.5~2.0kgf.
  - REMOVAL FORCE: 0.8kgf~2.0kgf.
  - DURABILITY: 10000 CYCLES.
- ELECTRICAL PERFORMANCE,
  - CURRENT RATING: 5A  
VOLTAGE RATING: 20V
  - INSULATION RESISTANCE: 100MΩ MIN
  - DIELECTRIC WITHSTAND VOLTAGE, AC 100V FOR 1 MINUTE
  - LOW CONTACT RESISTANCE: INITIAL 40M2AFTER 50M2
- ENVIRONMENTAL PERFORMANCE: OPERATING TEMPERATURE: -30°C~+80°C
- IR REFLOW: THE PEAK TEMPERATURE ON THE BOARD SHALL BE MAINTAINED FOR 10 SECONDS AT 260C

PIN ASSIGNMENTS

A5	CC1	B12	GND
A9	VBUS	B9	VBUS
		B5	CC2
		B1	GND
PIN	SIGNAL NAME	PIN	SIGNAL NAME

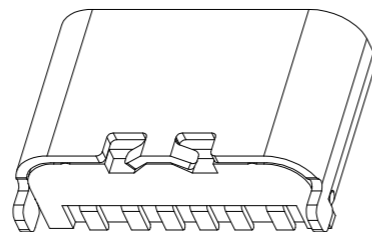

TOLERANCE

X. XXX	±0.05
X. XX	±0.15
X. X	±0.20
X.	±0.30
ANGLE	±5.0°

PROTECTON

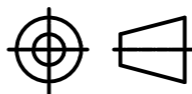

东莞市恒祺电子科技有限公司  
Dongguan Hengqi Electronic Technology Co., Ltd

<https://www.hq-dz.com>

phone: 15812872448

TITLE:

TYPE C 6P立式贴片L=6.5

PART NO: TYPE-C6P-LT1065

DRAWING NO: 8.64\*6.5\*3.16

DRAWN:

CHECKED:

APPROVED:

DATE:

DATE:

DATE:

18-10-08

18-10-08

18-10-08

UNIT:  
mm

SCALE:  
FULL

SIZE:  
A4

RoHS2.0  
Compliant

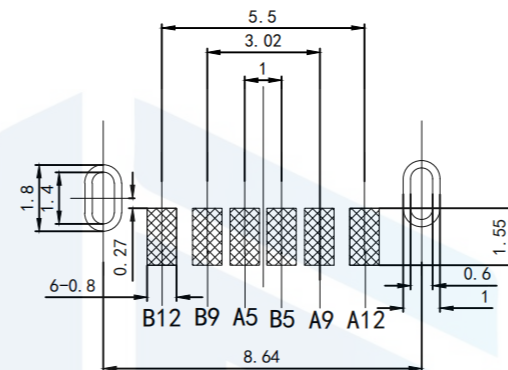
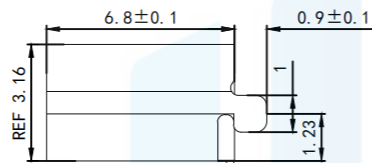
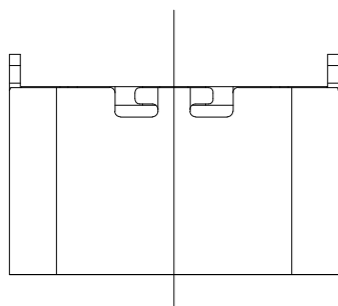

RECOMMENDED PCB LAYOUT

TOLERANCE UNSPECIFIED ±0.05mm

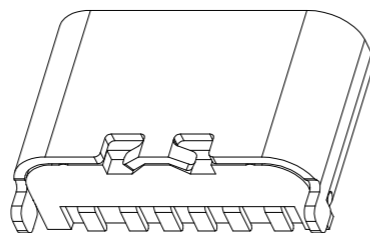
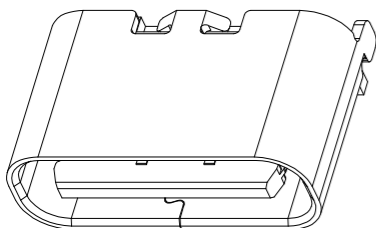
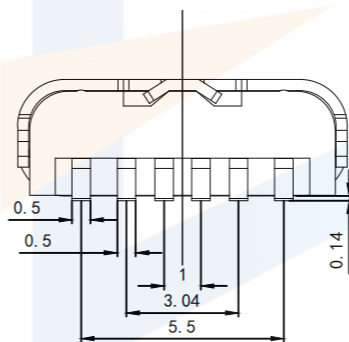
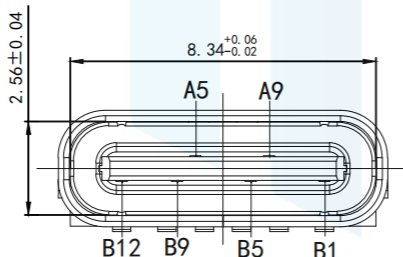
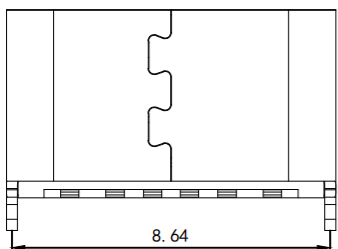

NOTE:

1. MATERIAL SPECIFICATION:
  1. HOUSING: HIGH TEMPERATURE RESISTANT PLASTIC, UL94 V-0.
  2. CONTACTS: COPPER ALLOY
  3. MID PLATE: STAINLESS STEEL
2. PLATING SPECIFICATION:
  - 2-1. CONTACTS:
    - Ni 50U" MIN. UNDER PLATED OVER ALL.
    - AU PLATED ON THE FUNCTIONAL AREA OF CONTACT (GOLD PLATING THICKNESS FOLLOW THE P/N)
    - GOLD FLASH PLATING ON SOLDER AREA
  - 2-2. FRONT SHELL:
    - Ni 30U" MIN. UNDER PLATED OVER ALL
3. MECHANICAL PERFORMANCE,
  - 3-1. INSERTION FORCE: 0.5~2.0kgf.
  - 3-2. REMOVAL FORCE: 0.8kgf~2.0kgf.
  - 3-3. DURABILITY: 10000 CYCLES.
4. ELECTRICAL PERFORMANCE,
  - 4-1. CURRENT RATING: 5A
  - VOLTAGE RATING: 20V
  - 4-2. INSULATION RESISTANCE: 100MΩ MIN
  - 4-3. DIELECTRIC WITHSTAND VOLTAGE, AC 100V FOR 1 MINUTE
  - 4-4. LOW CONTACT RESISTANCE: INITIAL 40M2AFTER 50M2
5. ENVIRONMENTAL PERFORMANCE: OPERATING TEMPERATURE: -30°C~+80°C
6. IR REFLOW:
  - THE PEAK TEMPERATURE ON THE BOARD SHALL BE MAINTAINED FOR 10 SECONDS AT 260C

PIN ASSIGNMENTS

A5	CC1	B12	GND
A9	VBUS	B9	VBUS
		B5	CC2
		B1	GND
PIN	SIGNAL NAME	PIN	SIGNAL NAME

TOLERANCE

X. XXX	±0.05
X. XX	±0.15
X. X	±0.20
X.	±0.30
ANGLE	±5.0°

PROTECTON

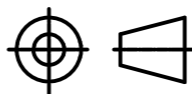

东莞市恒祺电子科技有限公司  
Dongguan Hengqi Electronic Technology Co., Ltd

<https://www.hq-dz.com>

phone: 15812872448

TITLE:

TYPE C 6P立式贴片L=6.8

PART NO: TYPE-C6P-LT1065A

DRAWING NO: 8.64\*6.8\*3.16

DRAWN:

CHECKED:

APPROVED:

DATE: 18-10-08

DATE: 18-10-08

DATE: 18-10-08

UNIT: mm

SCALE: FULL

SIZE: A4

RoHS2.0  
Compliant

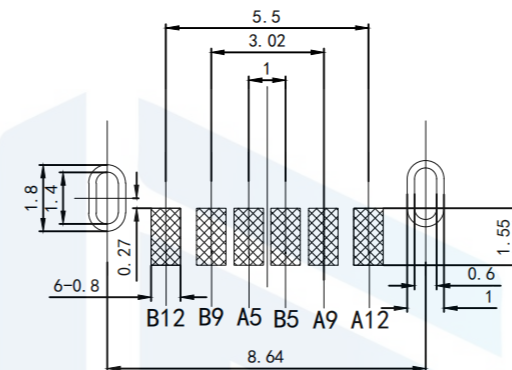
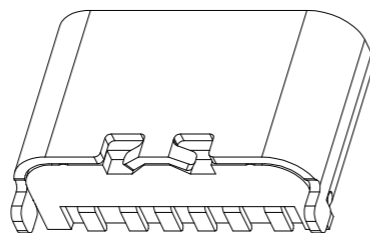
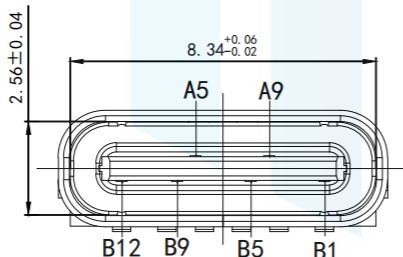
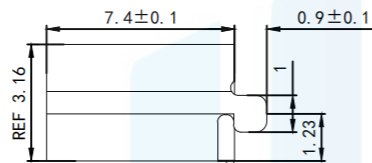
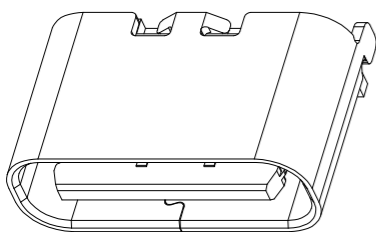
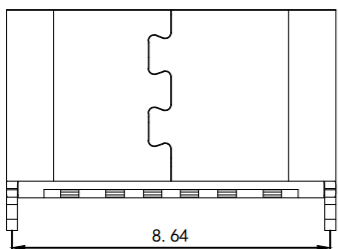
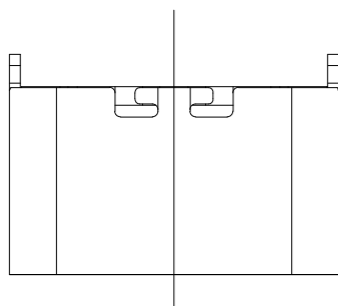

RECOMMENDED PCB LAYOUT  
TOLERANCE UNSPECIFIED ±0.05mm

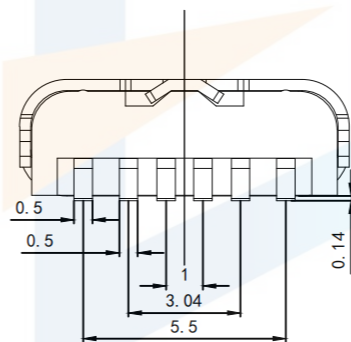

NOTE:

- MATERIAL SPECIFICATION:
  - HOUSING: HIGH TEMPERATURE RESISTANT PLASTIC, UL94 V-0.
  - CONTACTS: COPPER ALLOY
  - MID PLATE: STAINLESS STEEL
- PLATING SPECIFICATION:
  - CONTACTS:
    - Ni 50U" MIN. UNDER PLATED OVER ALL. AU PLATED ON THE FUNCTIONAL AREA OF CONTACT (GOLD PLATING THICKNESS FOLLOW THE P/N) GOLD FLASH PLATING ON SOLDER AREA
    - FRONT SHELL:
      - Ni 30U" MIN. UNDER PLATED OVER ALL
- MECHANICAL PERFORMANCE,
  - INSERTION FORCE: 0.5~2.0kgf.
  - REMOVAL FORCE: 0.8kgf~2.0kgf.
  - DURABILITY: 10000 CYCLES.
- ELECTRICAL PERFORMANCE,
  - CURRENT RATING: 5A  
VOLTAGE RATING: 20V
  - INSULATION RESISTANCE: 100MΩ MIN
  - DIELECTRIC WITHSTAND VOLTAGE, AC 100V FOR 1 MINUTE
  - LOW CONTACT RESISTANCE: INITIAL 40M2 AFTER 50M2
- ENVIRONMENTAL PERFORMANCE: OPERATING TEMPERATURE: -30°C~+80°C
- IR REFLOW: THE PEAK TEMPERATURE ON THE BOARD SHALL BE MAINTAINED FOR 10 SECONDS AT 260C

PIN ASSIGNMENTS

A5	CC1	B12	GND
A9	VBUS	B9	VBUS
		B5	CC2
		B1	GND
PIN	SIGNAL NAME	PIN	SIGNAL NAME

TOLERANCE

X. XXX	±0.05
X. XX	±0.15
X. X	±0.20
X.	±0.30
ANGLE	±5.0°

PROTECTON

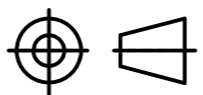

东莞市恒祺电子科技有限公司  
Dongguan Hengqi Electronic Technology Co., Ltd

<https://www.hq-dz.com> phone:15812872448

TITLE:  
TYPE C 6P立式贴片L=7.4

PART NO:TYPE-C6P-LT1065B

DRAWING NO:8.64\*7.4\*3.16

DRAWN:

DATE: 18-10-08

UNIT:  
mm

CHECKED:

DATE: 18-10-08

SCALE:  
FULL

APPROVED:

DATE: 18-10-08

SIZE:  
A4