

RoHS2.0
Compliant

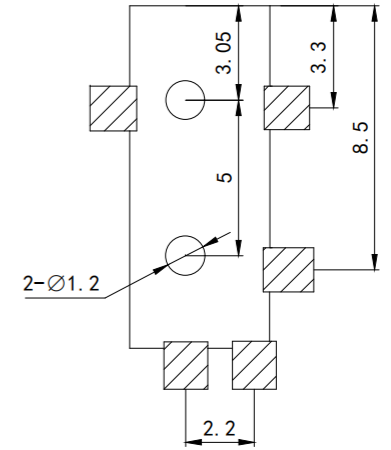

P. C. B LAYOUT TOP VIEW

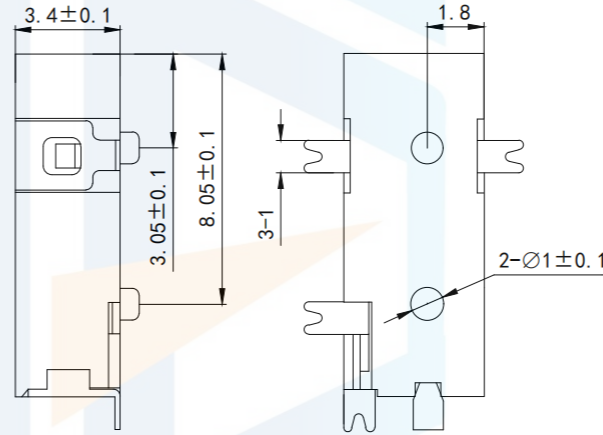
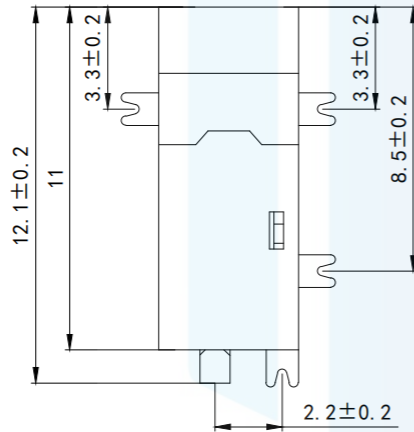
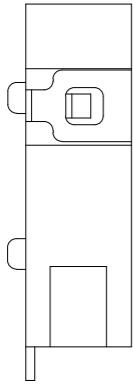
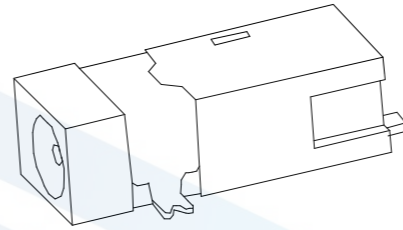
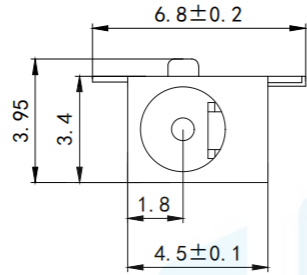
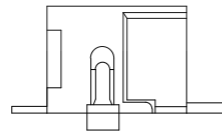
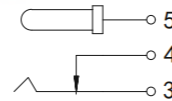

Technical requirements

1. Rated load: DC 30V 0.2A
2. Contact resistance: $\leq 0.03 \Omega$
3. Insulation resistance: $\geq 100 \Omega$ DC250V
4. Withstand voltage: AC 500V(50Hz)/min
5. Insertion force: 3~20N
6. Mechanical life: 5000 times
7. Operation temperature range: $-40^{\circ}\text{C} \sim 55^{\circ}\text{C}$

TOLERANCE

X. XXX	± 0.05
X. XX	± 0.15
X. X	± 0.20
X.	± 0.30
ANGLE	$\pm 5.0^{\circ}$

PROTECTON

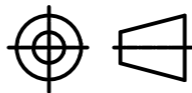

东莞市恒祺电子科技有限公司

Dongguan Hengqi Electronic Technology Co., Ltd

<https://www.hq-dz.com>

phone: 15812872448

TITLE:

DC电源插座

PART NO: DC-078

DRAWING NO: 12*4.5*3.4

DRAWN:

DATE:

18-10-08

UNIT:
mm

CHECKED:

DATE:

18-10-08

SCALE:
FULL

APPROVED:

DATE:

18-10-08

SIZE:
A4