

RoHS2.0  
Compliant

CIRCUIT DIAGRAM

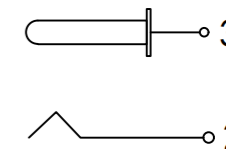

PCB LAYOUT TOP VIEW

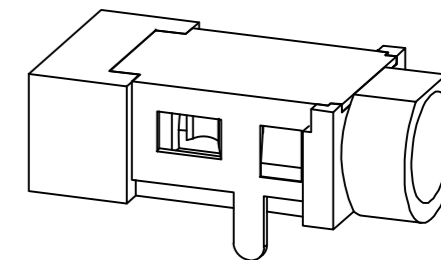
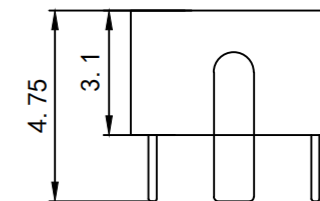
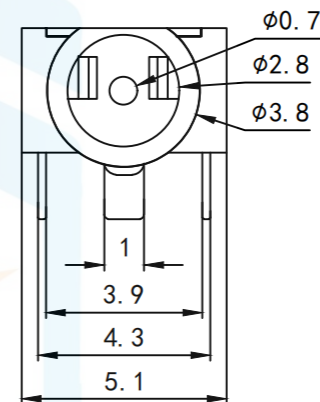
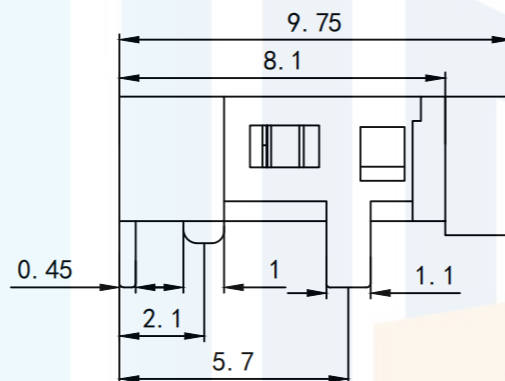
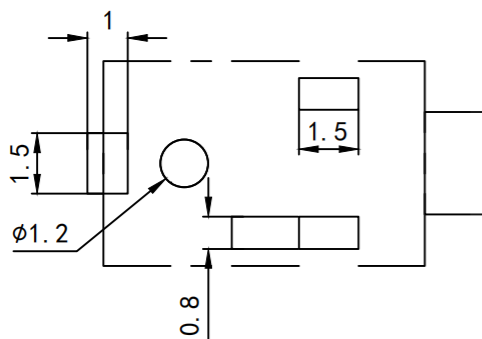

DC power socket series main technical indicators

1. Operating temperature range  $-30^{\circ}\text{C} \rightarrow 70^{\circ}\text{C}$
2. Withstand voltage 500V, (AC) /min
3. Rated load 30V DC 1.0A (the part can pass 3A base on customer actual test)
4. Action force 3N-20N
5. Contact resistance  $< 0.03\Omega$
6. Insulation resistance  $> 100M\Omega$
7. Life span 5000 times

TOLERANCE

X. XXX	$\pm 0.05$
X. XX	$\pm 0.15$
X. X	$\pm 0.20$
X.	$\pm 0.30$
ANGLE	$\pm 5.0^{\circ}$

PROTECTON

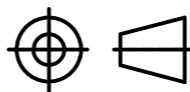

东莞市恒祺电子科技有限公司

Dongguan Hengqi Electronic Technology Co., Ltd

<https://www.hq-dz.com>

phone: 15812872448

TITLE:

DC电源插座

PART NO: DC-055A

DRAWING NO: 9.75\*5.1\*3.1

DRAWN:

DATE:

18-10-08

UNIT:  
mm

CHECKED:

DATE:

18-10-08

SCALE:  
FULL

APPROVED:

DATE:

18-10-08

SIZE:  
A4