

RoHS2.0
Compliant

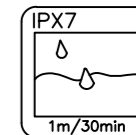

3D VIEW

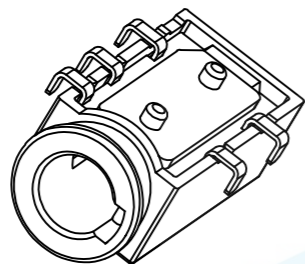
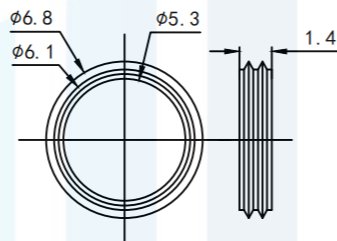

BLACK WATERPROOF RING

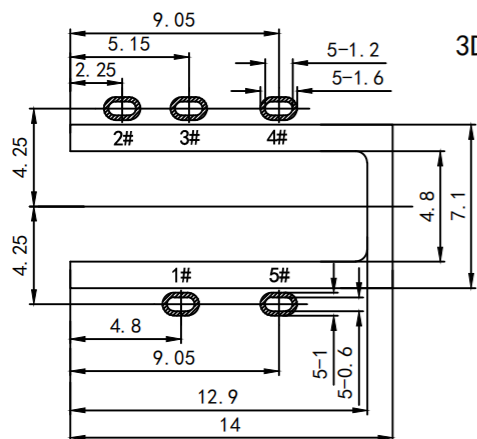
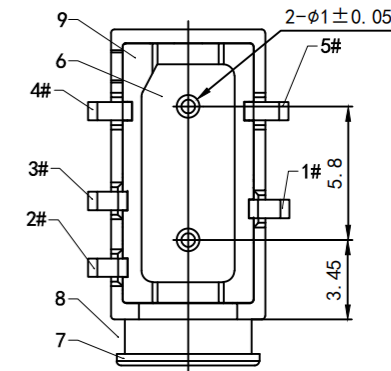
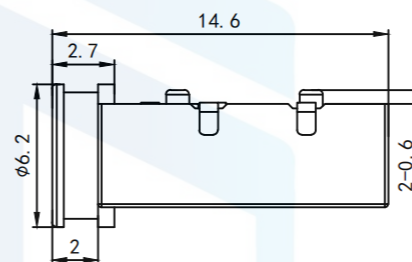

PCB LAYOUT (TOP VIEW)
TOLERANCE: ±0.05

NOTES

1. CURRENT RATING: 1A.
2. CONTACT RESISTANCE: 100mΩ MAX.
3. INSULATION RESISTANCE: 100MΩ MIN.
4. DIELECTRIC WITHSTANDING: 500V AC MIN.
5. DURABILITY: 5000 CYCLES MIN.
6. CONNECTOR MATING FORCES: 3~30N.
7. CONNECTOR UNMATING FORCES: 3~30NX.
8. SALT SPRAY: 24HOUR
9. WATERPROOF LEVEL: IP67.
10. OPERATING TEMPERATURE: -25° C TO +85° C.

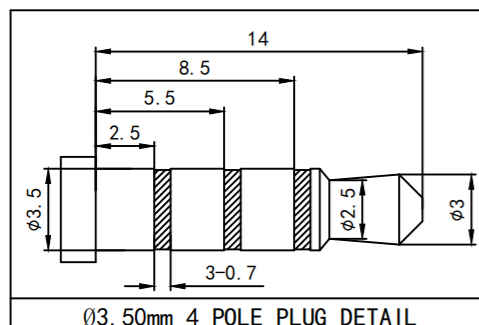
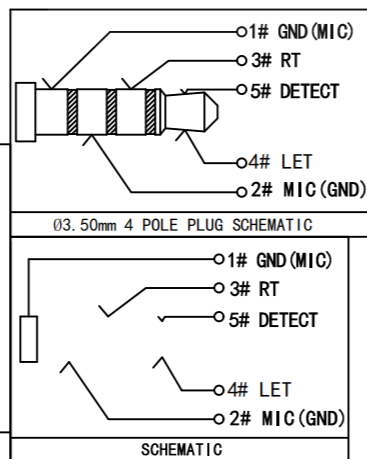
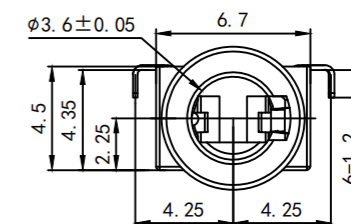
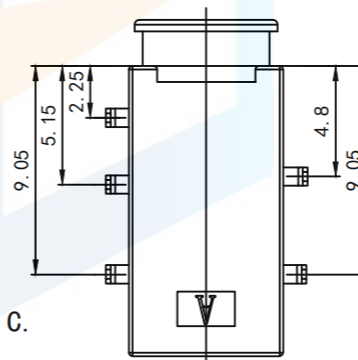

TOLERANCE	X. XXX	±0.05		东莞市恒祺电子科技有限公司	
	X. XX	±0.15		Dongguan Hengqi Electronic Technology Co., Ltd	
X. X	X. X	±0.20	https://www.hq-dz.com		phone:15812872448
	X.	±0.30	TITLE: 防水耳机插座		PART NO: PJ-3016
ANGLE		±5.0°	DRAWING NO: 14.6*6.7*4.5		
PROTECTON		DRAWN:	DATE:	18-10-08	UNIT: mm
		CHECKED:	DATE:	18-10-08	SCALE: FULL
		APPROVED:	DATE:	18-10-08	SIZE: A4